

our products

General Catalog

advanced and reliable

advanced and reliable

our products come with an integrated range of
global services as standard

designed for life at sea

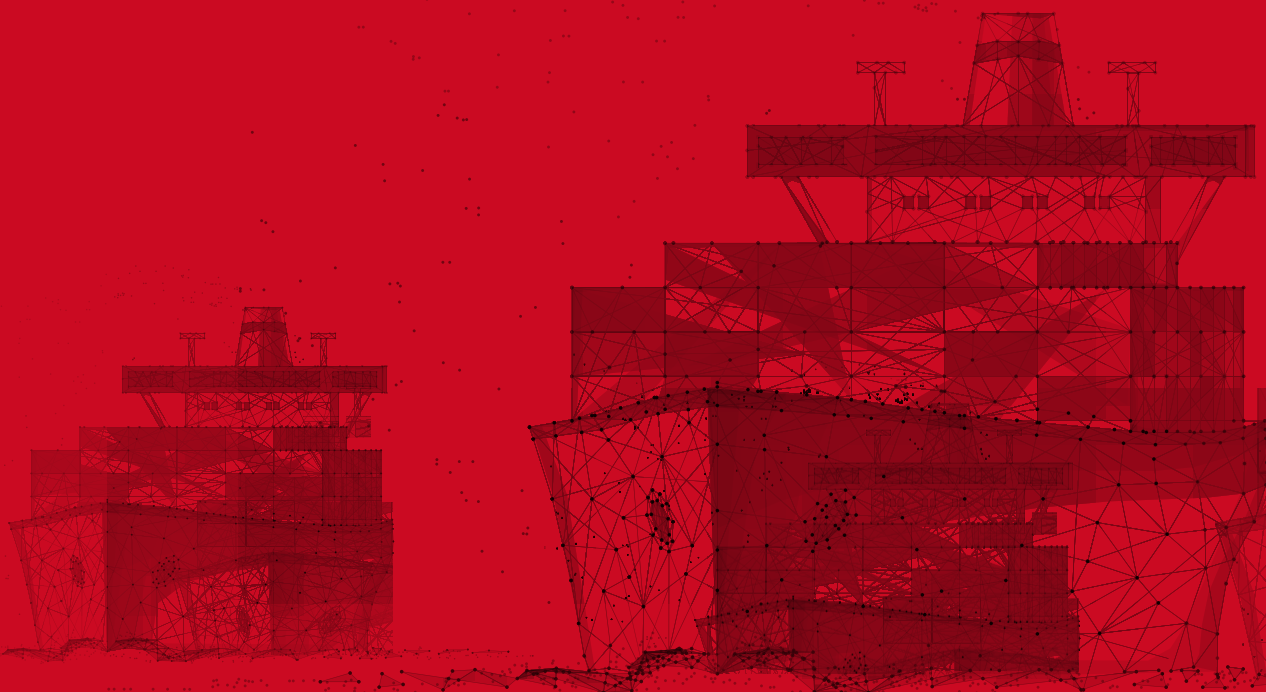

Index

Navigation

Radar	3
ECDIS	6
VDR	7
AIS	8
BNWAS	8
GPS Compass	9
GPS Navigator	9
Echo Sounder	10
Speed Log	11
Bridge System	12

Communication

Inmarsat Fleet Xpress	13
Inmarsat C	15
MF/HF Radio Equipment	16
Marine VHF Radiotelephone	16
NAVTEX Receiver	17
VHF/UHF Handheld	17
Weather Fax	18
EPIRB	19
Radar Transponder	19

Service

Information Service (J-Marine Cloud)	20
Remote Maintenance System (RMS)	22
Life Cycle Management (LCM)	22
JRC Global Service Network	23



EU Marine Equipment Directive (MED) compliant equipment
Equipment recognized as MED compliant



GMDSS compatible equipment
Equipment compliant with onboard requirements for GMDSS



Inmarsat type approval equipment
Satellite communication equipment that has been type approved by Inmarsat



Innovation Endorsement (IE)
Acquired Products & Solutions



Remote Maintenance System compatible equipment
Equipment compatible with remote diagnosis by remote maintenance system

Radar

Radar



The **JMR-9200 series** (26-inch monitor) and **JMR-7200 series** (19-inch monitor) are devices with outstanding performance and a wide range of powerful features that were developed by JRC's extensive experience and advanced technological capabilities. These devices are compliant with the latest IMO resolutions and are equipped with a high-performance radar signal processor developed independently by JRC by incorporating our advanced technologies, boasting superior performance that is unequaled by competitors. Also, dedicated controls are functionally arranged and categorized based on an ergonomic design for providing stress-free and comfortable operation, while the high-resolution video and sophisticated menu structure enable greater ease of viewing and operation. By combining these superior core technologies with advanced reliability design, the JMR-9200 series and JMR-7200 series have achieved the world's top level of high reliability and have been highly evaluated by many customers.



JMR-9200 Series

For more information,
Visit our website



Products lineup

Radar antennas are available in two types: X-band radar, which uses a frequency of approximately 9.4 GHz, and S-band radar, which uses a frequency of approximately 3 GHz, and their sizes range from 6 feet to 12 feet. With this extensive lineup, we can provide the ideal system to match your specific needs.

	JMR-7200 Series	JMR-9200 Series
Radar Antenna	6, 7, 9 feet X-band 12 feet S-band Solid-state 6 feet X-band Solid-state 9 feet X-band Solid-state 8 feet S-band Solid-state 12 feet S-band	
Output power	10, 25, 30 kW magnetron 250, 600 W solid-state	
Range scale	0.125-96 NM	
High-speed antenna	○	
Display	19-inch	26-inch wide
Diameter (PPI)	250 mm	320 mm
Target tracking	Up to 100 targets	
AIS	Up to 500 targets (optionally up to 1000 targets)	
Real-time head-up (Constaview)	○	
Target enhancement function (TEF)	○	

Radar

Features

Safety Zone Viewer function

By displaying areas of high collision risk on the radar screen, navigators can intuitively grasp safe navigation areas. It is also effective in planning a course of avoidance in congested waters, as the safe course can be seen at a glance.

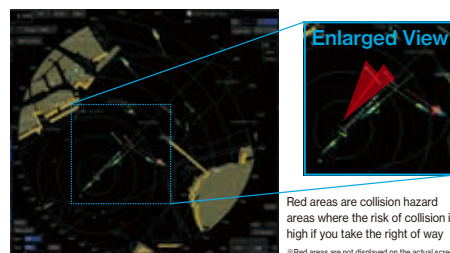

Example of the Safety Zone Viewer Screen Display

VHF remote operation

The radar offers a VHF remote operation function¹. This can be used to configure channels on the VHF unit or to perform DSC² calls using AIS targets on the radar PPI screen. Features such as the wireless speaker microphone³ make it possible to communicate with other ships even when away from the VHF equipment.

*1 : JHS-800S is supported.

*2 : Digital Selective Calling (Digital Selective Calling)

Used in routine calls, safety and urgency calls, and distress alerts for rescue request.

*3 : Wireless speaker microphone is option for the JHS-800S.

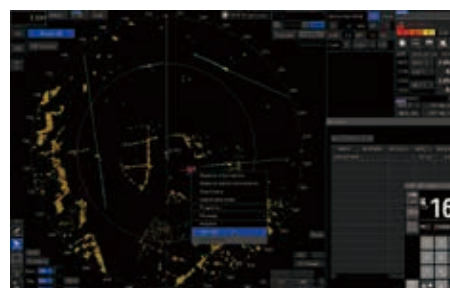

Radar JMR-9200 Series 26-inch Display Screen

Compatible with solid-state radar antenna

The MED test are obtained for the X-band and S-band solid-state models.

– No preheating or tuning required

No preheating or tuning is required. A stable image will be obtained promptly after the power is turned on.

– A built-in Doppler filter clearly extracts target objects

Conventional magnetron radars have difficulty in using Doppler filters. A new digital signal processing method has made improvements in target detection performance in clutters.

– Magnetron replacement unnecessary

The product adopted a highly reliable solid-state transmission circuit, thus eliminating periodical magnetron replacement and leading to a maintenance cost reduction.



6 feet X-band 600 W



9 feet X-band 600 W



8 feet S-band 250 W

Functional expansion

The equipment incorporates a variety of optional functions that will be available with software licenses added. Software licenses can be added before or after the radar comes into operation. Therefore, the radar can be customized to match the actual operating conditions.

– Chart radar function⁴

– Safety Zone Viewer function⁵

– Wave analysis function

– Expansion of AIS display targets (500 → 1,000)

*4 : The chart radar function requires ENC cell permits as well as ECDIS.

*5 : Supported by software after June 2022.

Wave analysis supports safe and fuel-efficient voyages

Sea surface reflection signals obtained around the own ship by the X-band radar are analyzed to display wave height, wave direction, wavelength, and wave cycle information along with spectrum images⁶. The ship can take a course on the basis of information obtained from the wave analysis and suppress the pitching and rolling of the ship caused by waves, thus making it possible to ensure the safety of the crew members and cargo while saving the fuel consumption.

*6 : The spectrum image is available to JMR-9200 series on.

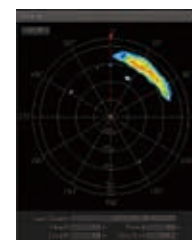

Example of Wave Analysis Display

Radar

Radar



The **JMR-5400 series** is equipped with a top-of-the-line processor which is used in the JMR-9200/7200 series, remarkably improving target detection and drawing performance alike. Additionally, a variety of radars are available, including the newest radar antennas scanner unit, and solid-state radar antennas. It also complies with the latest IMO resolutions.

For more information, Visit our website



JMR-5400 Series

Features

Second PPI display ^{*1}

The display range can be set differently from the main PPI, allowing sectional magnification of the area around the own ship within the main PPI.

*1 : Compatible with 26-inch wide display only.

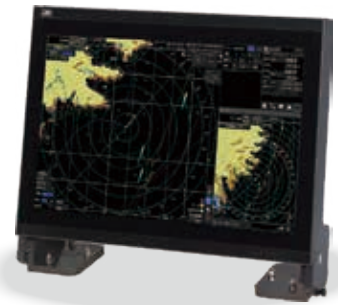

Example of Second PPI Display

8 ft S-band solid-state radar antenna

The solid-state radar antenna, which was previously designed for large vessels, has a more compact and lightweight design for enabling installation on small and medium-sized vessels.



8 feet S-band 250 W

Advanced magnetron radar antenna

A newly tuned system cuts search times to roughly 5 seconds to 1.25 seconds of what they were previously. Additionally, thinning of the antenna height means improved drive device reliability.



9 feet S-band 25 kW

TT/AIS display functionality

Equipped with TT functionality by default, allowing users to mark other ships and points of interest with TT symbols and check the course of nearby objects at a glance. The same highlighting functionality is also available for AIS symbols.

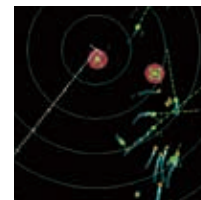

TT Function/ AIS Display Function

Original menu

Create original menus that include only the items you need, and a favorites list to bring up frequently used items in one location.

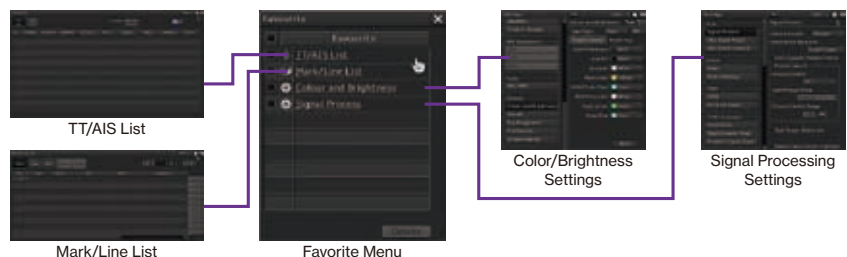

ECDIS

ECDIS

The **JAN-9201** (26-inch wide) and **JAN-7201** (19-inch) are multi-functional ECDIS that complies with the latest IMO resolutions. It uses images obtained from the AIS and the radar system and superposes the images with navigational chart information, thus accurately displaying dynamic information on other ships around. It is the navigational information equipment to support the safety navigation of ships at sea.



JAN-9201

For more information,
Visit our website



Features

- Conforming to the latest IMO performance standards with Marine Equipment Directive (MED) certification
- Ensuring intuitive and easy-to-use display and operation performance reflecting professional user's voices
- Integrating route editing and route safety checking to support safer route plans
- Delivered with a software license allowing an expansion tailored to each operational requirement for a wide variety of optional features
- ECDIS type-specific training (TST) is provided by a variety of organizations around the world on behalf of JRC

Functional expansion

The equipment incorporates a variety of optional functions that will be available with software licenses added. Software licenses can be added before or after the ECDIS comes into operation. Therefore, the radar can be customized to match the actual operating conditions.

- Expansion of AIS display targets (500 → 1,000)
- Radar overlay function¹
- Track Control System (TCS) support²
- Joystick steering system support³



Example of Satellite Transmission Blocking Area Display

*1: The radar overlay function requires an optional radar interface circuit and radar image signal input.

*2: TCS is a function that calculates the command heading based on the route planned on the ECDIS and own ship's position, and transmits the value to the autopilot to automatically hold the ship on the preset route. The TCS function requires the autopilot connection.

*3: The ECDIS can interface with the Made by Yokogawa Denshikiki: STEERING JOYSTICK CONTROLLER or the Made by TOKYO KEIKI: Multi-function Joystick System. It requires the autopilot connection compatible with the joystick steering system.



JAN-7201S

ECDIS

The **JAN-7201S** (19-inch monitor) and **JAN-9201S** (26-inch monitor) are ECDIS that are based on JAN-7201/9201, which conform to the latest IMO resolutions. They are cost-effective ECDIS suitable for equipping or retrofitting ECDIS to existing vessels.



For more information,
Visit our website



Features

- Conforming to the latest IMO performance standards with Marine Equipment Directive (MED) certification
- Ensuring intuitive and easy-to-use display and operation performance reflecting professional user's voices
- Integrating route editing and route safety checking to support safer route plans
- ECDIS type-specific training (TST) is provided by a variety of organizations around the world on behalf of JRC
- Available in 19-inch (SXGA) and 26-inch wide (WUXGA) models of 2 types



VDR

VDR



The JCY-1900 is a device that records the date and time, vessel's position, heading, speed, hull status, and bridge conversations during a voyage. It can be used to help determine the cause of maritime accidents and prevent their recurrence. The JCY-1900 conforms to the latest IMO resolutions and meets the requirements for installation on all vessels. It incorporates the latest advancements in technology utilizing an industry standard capsule that provides durability and improved safety at sea.

For more information, Visit our website



Features

- 7-inch wide VGA color LCD touch panel
- IP-based easy equipping
- Highly reliable capsule and onboard equipment
- Equipped with a check function for recorded contents
- Equipped with our original remote maintenance system as standard



JCY-1900

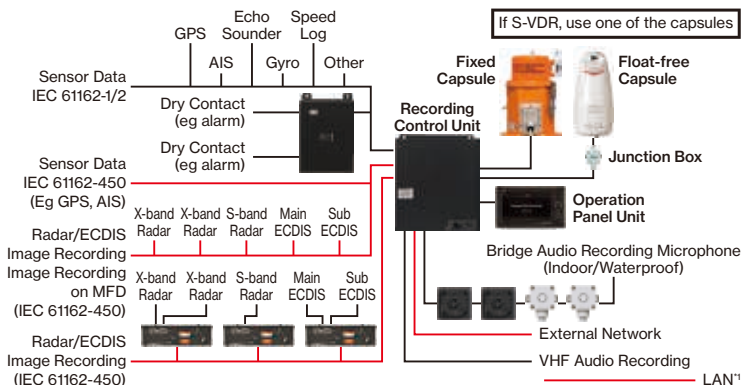

System Diagrams

The VDR can be connected to various navigation and communication equipment and sensors onboard a ship. JRC's straightforward configuration assures continuous performance of the VDR system.

*1 : If you want to connect 5 or more ports, please use the 100BASE-T compatible HUB.

Information Service

JRC offers our Information Service (Smart Ship Viewer) using our VDRs and J-Marine NeCST. By installing a high-capacity, high-speed satellite communication service² (Fleet Xpress provided by Inmarsat), the status of ships being managed can be viewed at any time from the management company office.

*2 : This service is based on the installation of Inmarsat FX or VSAT.



Ship Monitoring

Ship movements and the status of its onboard equipment can be monitored from a PC or smartphone on land.



VDR Data Download

This is a service that allows data stored in the VDR/S-VDR³ to be downloaded on land. The downloaded data can be replayed using the VDR Real Time Monitor⁴ software.

*3 : Compatible with JCY-1900/1950.

*4 : Software of JRC. Please contact us for more information.

AIS BNWAS

Navigation

Communication

Service

AIS



The **JHS-183** is a system for periodic transmission of voyage information, such as the ship's position, course, and speed, as well as ship's name and cargo, over the VHF band, and it constantly receives and displays this type of ship information transmitted by other vessels. In accordance with the revision of the SOLAS (Safety of Life at Sea) Convention in 2000, AIS became mandatory for all passenger ships, vessels of 300 GT or more engaged in international voyages, and vessels of 500 GT or more not engaged in international voyages. Various types of vessel information (vessel name, MMSI, etc., as well as vessel position, course, speed, etc.) can be transmitted and received.

For more information,
Visit our website



Features

- 4.5-inch high-brightness LCD panel for superior visibility
- Dual-color (white or orange) selectable LED backlight
- JRC's proven transponder with integrated antenna
- Requires only single coaxial cable for connecting the controller to the transponder
- Pilot plug port provided as standard



JHS-183

BNWAS



The **JCX-161** is intended to monitor the presence or inattention of the watch officers and to detect dangerous vessel operation conditions at an early stage.

For more information,
Visit our website



Features

- 4.5-inch high-brightness LCD panel for superior visibility
- Dual-color (white or orange) selectable LED backlight
- Standard support for alarm input from navigational equipment
- Newly designed, compact, lightweight, low power consumption peripheral devices
- Conform to IMO resolution MSC.128 (75)



JCX-161



Motion Sensor



LED Warning Lamp



Reset Button



Buzzer

Reset Button (Waterproof)

GPS Compass GPS Navigator



GPS Compass

The **JLR-21/31** the latest technology to provide stable and accurate "true heading" data that enables safe and effective vessel navigation at sea.

For more information,
Visit our website



Features

- 5.7-inch display
- Fully integrated roll, pitch and rate of turn
- Various display modes available
- High speed tracking response (ROT 45°/sec)
- Approved as Transmitting Heading Device



JLR-21/31



Sensor NNN-21



Sensor NNN-31

GPS Navigator



The **JLR-8600/8400** is a GPS navigator with improved positioning accuracy using a new type of GPS sensor compatible with multi-GNSS^{*1}. It provides high-accuracy position information for contributing to safer vessel operations.

*1 : GPS, GLONASS, BeiDou, SBAS

For more information,
Visit our website



Features

- Newly developed GPS sensor for capturing even more accurate position information
- System for providing stable, high-accuracy information
- Easy-to-use user interface (JLR-8600)
- Flexible expandability and superior ease of use (JLR-8600)
- Lineup includes an integrated model (JLR-8400) similar to previous models



GPS Sensor
JLR-4350



JLR-8400 (Integrated Model)^{*2}
Display Unit NWZ-4620



JLR-8600 (Stand-alone Model)^{*2}
Display Unit NWZ-1650

*2 : The integrated model consists of a sensor and a display unit with a built-in processor. The stand-alone model consists of a sensor, display, and processor.

Echo Sounder



Echo Sounder

Both the **JFE-400** and **JFE-700** echo sounders continue the tradition of enhanced depth technology with highly accuracy and reliability.

For more information,
Visit our website



JFE-400



JFE-700

Features

- Conforming to the IMO Resolution MSC.74 (69) Annex 4
- Separate and all-in-one models available
- Achieves extremely accurate and reliable sounding performance
- Use a highly visibility color touch panel LCD
- Memory and read-out up to 48 hours of depth data

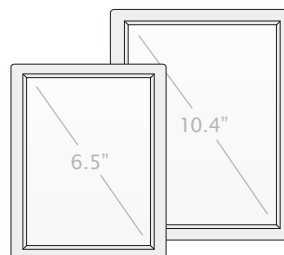

Flexible installation

The **JFE-400/JFE-700** enables connection of two transmitters/receivers to one unit for allowing separate bow and stern depths read-outs. A dual frequency configuration, 50 kHz and 200 kHz, is available for enabling you to use both frequencies independently or simultaneously.

50 kHz

200 kHz

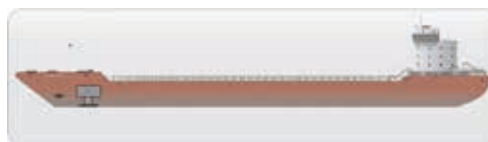

Single frequency
50 kHz
200 kHz

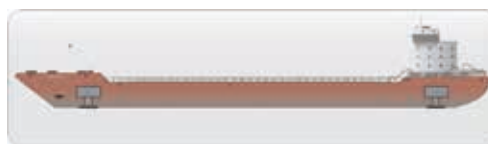

Fore/aft
50+50 kHz or
200+200 kHz

Dual frequency
50+200 kHz

The optimal installation location of the transmitter/receiver is determined according to the vessel type and the shape of the ship's bottom. Normally, the transmitter/receiver is installed at the bow of the ship, where the effect of air bubbles is less.

Speed Log

Satellite Log



The **JLN-720** measures ground speed using GPS satellite signals. It measures the ship's speed in three directions: transverse speed at bow and stern and longitudinal speed.

For more information, Visit our website



Features

- Comply with IEC 61023 (Ed.3), SDME standards for the ships
- Provide ship speed with high accuracy 0.02 kn or 0.2 %
- Offers transverse speed at bow and stern along with longitudinal speed, ROT and total/trip distance with the satellite signals
- Color LCD display with touch panel provides clear display and easy operation
- JRC original Remote Maintenance System(RMS) applicable

Doppler Speed Log



The **JLN-740 series** is an equipment that measures water speed. The JLN-740 series is our company's proprietary bubble detection, informs you when measurement accuracy is impaired due to air bubble contact.

For more information, Visit our website



Features

- IMO MSC.96 (72)-compliant Doppler Speed Log
- Measures ship speeds within a range of 0.03 kn or 0.3 % with greatly improved ship speed tracking to assist with precise navigation during berthing
- Equipped with proprietary bubble detection, which informs when speed detection is reduced due to bubble contact
- Color LCD display model with touch panel for improved night visibility is also available
- Also available in a three-unit model, which provides smaller ships with the same exceptional speed tracking capability

Speed Log



The **JLN-900** is equipped with a dual-use transducer for both ground and water for enabling independent ground speed and water speed measurements.

For more information, Visit our website



Features

- Full compliance with IMO MSC.334 (90) using a single device
- Enables measurement of ship speeds over ground up to depths of 250 m
- Three axis^{*1} SOG and one axis STW
- Correlation technology
- Compact, lightweight gate valve included as standard

*1 : Requires gyro signal input.

Bridge System

The AlphaBridge is designed to create a maximum level of awareness and ergonomics to ensure that the crew can work in a safe environment while operating maritime equipment becoming more complex.

For more information,
Visit our website



Features

Setting standards, in space saving design

The AlphaBridge aim is to minimize the space that each individual component uses on the bridge console, resulting in a solution that follows the latest thinking in ergonomics and class rules. Perfectly suited to even the largest container vessels with their relatively small wheelhouses.

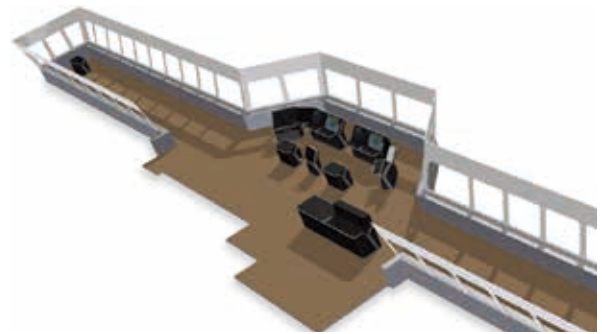

Modularization of bridge console

Because of its modular concept, AlphaBridge can be preassembled at Alpatron Marine workshops around the world. Factory acceptance tests are carried out before shipment, ensuring your satisfaction in the quality of our delivery. Special custom-made designs are available on request.



Standard Console



Raised Desk

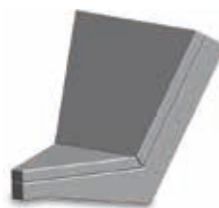

Wedge



Chart/GMDSS Console

Ergonomic design, safe operation

The ergonomic design of AlphaBridge follows regulations and enables intuitive, comfortable operation, which enhances the safety of your vessel.



Inmarsat Fleet Xpress

Fleet Xpress (FX)

Fleet Xpress (FX) is a fusion of the GX system (Ka-band communications) and the FB system (L-band communications). The FX system leverages the advantages of the two systems, using the GX system, which allows high-speed communication in clear weather, and switching to the FB system, which provides stable communication with limited communication speed, when weather conditions cause significant rain attenuation, providing users with high-speed and stable communication.

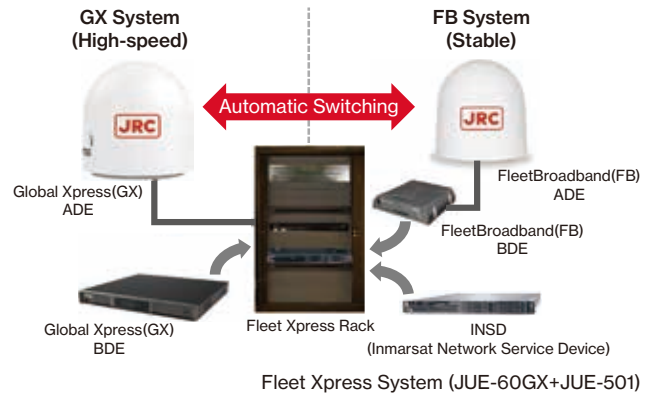

Satellite Communication One-stop Service

JRC provides a one-stop service for business operations which customers previously arranged individually, from communication terminals for VSAT systems such as Inmarsat Fleet Xpress to line contracts.

Global Xpress (60GX)

The JUE-60GX is a marine satellite communication terminal that provides various IP network services (Internet, e-mail, IP telephony, etc.) at high speed in a compact package using an easy-to-install 60-cm antenna.



For more information,
Visit our website



Features

- Ultra-high-speed data communication by the small size/lightweight antenna
- Can be used worldwide except for polar regions
- Anti-vibration resistance design by rigid structure
- Lightweight design by aluminized of the antenna frame JUE-60GX
- Adopt low attenuation and low reflection radome by the multi-layer honeycomb structure

Main Services of the GX System

	GX (JUE-60GX)
Internet access	Packing switching Best effort Uplink: Up to 5 Mbps Downlink: Up to 50 Mbps The maximum communication speed is determined by the communication charge contract.
Voice	VoIP Enables voice communication during data communication
Video chat	Videophone by using a smartphone or PC
Content distribution	Distribution of newspaper, video, voice, and marine chart

Satellite transmission blocking area display^{*1}

During communications between JRC INMARSAT FBB or INMARSAT GX^{*2} equipment and satellites, the radar equipment^{*3} can display satellite antenna reception levels, blocking conditions, and transmission suspension^{*4}.

*1: Satellite transmission blocking area display is option.

*2: The INMARSAT FBB and INMARSAT GX support the JUE-251/501 and the JUE-60GX.

*3: The JMR-9200/7200 series is supported.

*4: Transmission suspension supports only the JUE-60GX



Blocking Display Example

Inmarsat Fleet Xpress

FleetBroadband



The **JUE-501/251** is a marine satellite communication terminal with compact design and easy installation, enabling customers to quickly set up a high-speed communication environment themselves.

Features

- Supports best-effort high-speed data transmission up to 432 kbps^{*1}
- Supports streaming communications up to 256 kbps^{*2} for smooth video transmission
- Easy installation using a single coaxial antenna cable without requiring a gyro
- Various interfaces, networks, and security functions are included as standard features
- Built-in PBX (switcher) supporting extension phone lines, call forwarding, and more

*1 : For the JUE-501. The JUE-251 is 284 kbps.

*2 : For the JUE-501. The JUE-251 is 128 kbps.



JUE-501

For more information, Visit our website



JUE-251

For more information, Visit our website



	FB250 (JUE-251)	FB500 (JUE-501)
Standard IP	Up to 284 kbps	Up to 432 kbps
Streaming IP	8, 16, 32, 64, 128 kbps	8, 16, 32, 64, 128, 256 kbps
ISDN	64 kbps	
Voice	4 kbps, 3.1 kHz-Audio	
Fax	G3 fax (using 3.1 kHz-audio line)	
Short Message	Standard 3G (Up to 160 characters)	
Connection port	Handset×1, TEL/FAX×2, Ethernet×6, ISDN×1, WRF×1	

Supports connection to a wide variety of peripheral devices by adding junction boards

- 4 telephone lines (RJ-11)
- 4 external buzzers
- 1 Voice Distress Button
- Signal input (GPS, gyro)
- Signal output (remote power switch, multipurpose contact signal)



Inmarsat C

Inmarsat C system

The **JUE-87** is a highly reliable mobile satellite communication system that complies with the latest IMO resolutions on GMDSS. The JUE-87 provides accurate and economical global communications with a full range of standard features such as store-and-forward message communications and receiving of EGC messages.



For more information,
Visit our website



Features

- Compact all-in-one Internally Mounted Equipment with 10.4-inch display
- Newly designed Externally Mounted Equipment with high performance RF filter
- Only a single coaxial cable is required to connect EME and IME
- Long Range Identification and Tracking (LRIT) as standard
- Optional Ship Security Alert System (SSAS)



JUE-87

Ship Security Alert System: SSAS



JUE-95SA

The **JUE-95SA** is a security alert system that can be activated covertly in case of piracy or terrorist attacks by using discretely located alert buttons. The security alert system notifies the authorities in the flag nation that the ship's security is under threat or that a life-threatening situation exists. The system repeatedly sends an alert signal from the ship to the shore station, including the ship's ID, its position, and the time of day, until the alert button is deactivated. When activated, there is no buzzer sound so that people around the vessel are not aware that an alert has been sent out.

For more information,
Visit our website



Long Range Identification and Tracking: LRIT



JUE-95LT

The **JUE-95LT** is a dedicated LRIT device using the Inmarsat C system. The JUE-95LT conforms to the LRIT requirements specifications established by the IMO resolutions, and can be equipped at minimal cost due to its lightweight, compact size, and simple system configuration.

For more information,
Visit our website



Vessel Monitoring System: VMS



JUE-95VM

The **JUE-95VM** is a vessel location management system developed as a vessel monitoring system (VMS) for the Forum Fisheries Agency (FFA). Vessel location information is automatically transmitted to the FFA by polling from the FFA. As an optional feature, Inmarsat C messages can be sent and received by connecting a preselected DTE or PC.

For more information,
Visit our website



MF/HF Radio Equipment Marine VHF Radiotelephone

MF/HF



The **JSS-2150/2250/2500** features an intuitive user interface and advanced modular design that allows for ease of installation in confined spaces.

For more information,
Visit our website



Features

- 3.8-inch display
- Standard 6 channel DSC built-in
- Flexible black box configuration
- Digital audio and integrated speaker
- Easy operation with JOG dial



JSS-2150/2250/2500

GMDSS console

The GMDSS console is a stand-alone console for GMDSS-compliant MF/HF radio equipment and Inmarsat C. By integrating the radio devices, power supply, charger, emergency lights, GPS buffer, power distribution terminal block, and other components into a single housing, the console enables greater ease of operation and easier equipment installation.



GMDSS Console

VHF



The **JHS-800S** is the world's first Class A DSC-compliant marine VHF radiotelephone with a touch-panel LCD¹. The 5-inch high-brightness color touch-panel LCD is used as the operation panel, and an optimized button layout is used to enable intuitive operation.

For more information,
Visit our website



JHS-800S

Features

- World's first¹ touch-panel LCD in a marine VHF radiotelephone
- Specially designed speaker and a new handset design are used for enabling high-quality audio reception
- Compact design with integrated radio and operation unit for improved ease of use
- Bluetooth® connected wireless speaker microphone allows calls to be made on the move
- Easy DSC calling from an AIS target on JRC's ECDIS/radar screen

*1: Class A DSC-compliant marine VHF radiotelephone, as of April 2019.

*2: The call distance is up to 10 m. Our test values are not guaranteed values.

*3: The BTR-155 is optional.

*4: The Wireless speaker microphone BTR-155 is a product made by SAVOX Corporation.

- The Bluetooth® word mark and logos are registered trademark of Bluetooth SIG, INC.
- Bluetooth® interface: Bluetooth® 3.0 Class2



Wireless Speaker Microphone
BTR-155^{2-3*4}

NAVTEX Receiver VHF/UHF Transceiver

NAVTEX receiver



The **NCR-333** simultaneously receives navigational warnings, meteorological warnings, search and rescue information, and other information broadcast on three frequencies and displays it on the LCD screen. It can also be programmed to receive selected stations and messages. The NCR-333 has a message storage function for saving up to 200 messages from each channel for 70 hours and uses a high visibility LCD panel.

Features

- 5.7-inch display
- 3 receiving frequencies
- User selectable font style
- Printer output (option)
- Output to the JRC ECDIS is possible

For more information,
Visit our website



NCR-333



JHS-207



JHS-431

Two-way VHF radiotelephone



The **JHS-207** is a two-way VHF radiotelephone for rescue boat in accordance with SOLAS convention.

For more information,
Visit our website



Marine UHF Transceiver

The **JHS-431** is a UHF shipboard transceiver designed for shipboard, ship-to-ship, and ship-to-shore communications. It conforms to intrinsically safe explosion-proof structure standards (ATEX and NK standards)² and can be used on tankers, LPG carriers, and other flammable hazardous material carriers.

*1 : Intrinsically safe construction standard
ATEX Directive 94/9/EC
Gas: II2GD Ex ib IIA T3
Dust: II2GD Ex tD A21 T160° C

For more information,
Visit our website



Weather Fax

10-inch Recording Model



The **JAX-9B** is a weather facsimile receiver having a compact, lightweight, easy-to-use, and low-cost design with a 10-inch recording width for meeting customers' needs for operability, reliability, and maintenance costs.

For more information,
Visit our website



JAX-9B

Features

- 10-inch effective recording width
- Multiple recording modes available
- View image instantly with PC output option
- Automatic frequency selection
- Easy operation and highly reliable read-out

JAX-9B

JAX-9B	
Recording system	Solid-state recording by thermal head
Recording paper	Thermo-sensitive recording paper 260 mm×25 m roll
Effective recording width	256 mm (10-inch)
Index of cooperation	288 or 576
Scanning speed	60, 90, 120, 240 SPM
Scanning line density	Approx. 3.5 line/mm (288) or Approx. 7 line/mm (576)
Phase matching	Automatic and manual
External input	600 Ω 1900±400 Hz 0 dBm
Operation modes	1. Automatic recording 2. Manual recording 3. Forced recording 4. Timer program recording

EPIRB Radar Transponder

EPIRB

The Tron 60AIS is a device that, when a vessel is in distress, floats on the surface of the water to call for rescue, transmits distress and rescue signals to a satellite, and transmits search and rescue signals to an aircraft.



For more information,
Visit our website



Features

- Dual frequency support at 406 MHz and 121.5 MHz
- AIS homing signal transmission
- Equipped with GNSS receiver function
- Compact and lightweight for easy equipping
- Easy installation and flexible mounting
- Rust and degradation resistant structure
- Flexible antenna with high resistance to wind, vibration, etc.



Tron 60AIS

Radar Transponder

The Tron SART20 is designed for use in search and rescue operations. It is a life-saving device that transmits a response signal when it receives radar waves emitted from a 9 GHz band radar on board a vessel or aircraft to inform the searcher of its location.



For more information,
Visit our website



Features

- Conforms to GMDSS
- Small, compact, and portable design
- 5-year maintenance kit (replacement battery kit) for easy on-board servicing



Tron SART20

Information Service (J-Marine Cloud)



Information Service (J-Marine Cloud) is a service that aims for safe, secure, and smart ship operation management through the visualization of vessels. In the maritime field, Internet access has become easier owing to faster satellite communication services and with the advent of flat-rate plans. And so, today, the environment is in place to realize various solutions by sharing information between vessels and land and effectively utilizing such information for enabling visualization of vessels from land, which was difficult in the past.

For more information,
Visit our website



Features

Common platform for collecting and providing informant

J-Marine Cloud functions as a common platform to collect various types of information and provide a diversity of contents.

Smart Ship Viewer SSV Mobile JM-Weather

Information collected from ships and shore compiled as a database

Various types of information are collected from weather and oceanographic information providers, shore-based radar stations and AIS shore stations (to be installed separately) and are compiled as a database for superimposed display on multiple monitors and PCs.

J-Marine Cloud J-Marine NeCST NeCST Manager Smart Ship Viewer

Solutions to various problems with ship operations

J-Marine Cloud supports the improvement and solution of various problems with navigation and ship operations including energy-saving navigation and environmental measures, anti-piracy measures, proper support from shore of ship operations.

Smart Ship Viewer J-Marine NeCST J-Marine GIS Remote Maintenance System

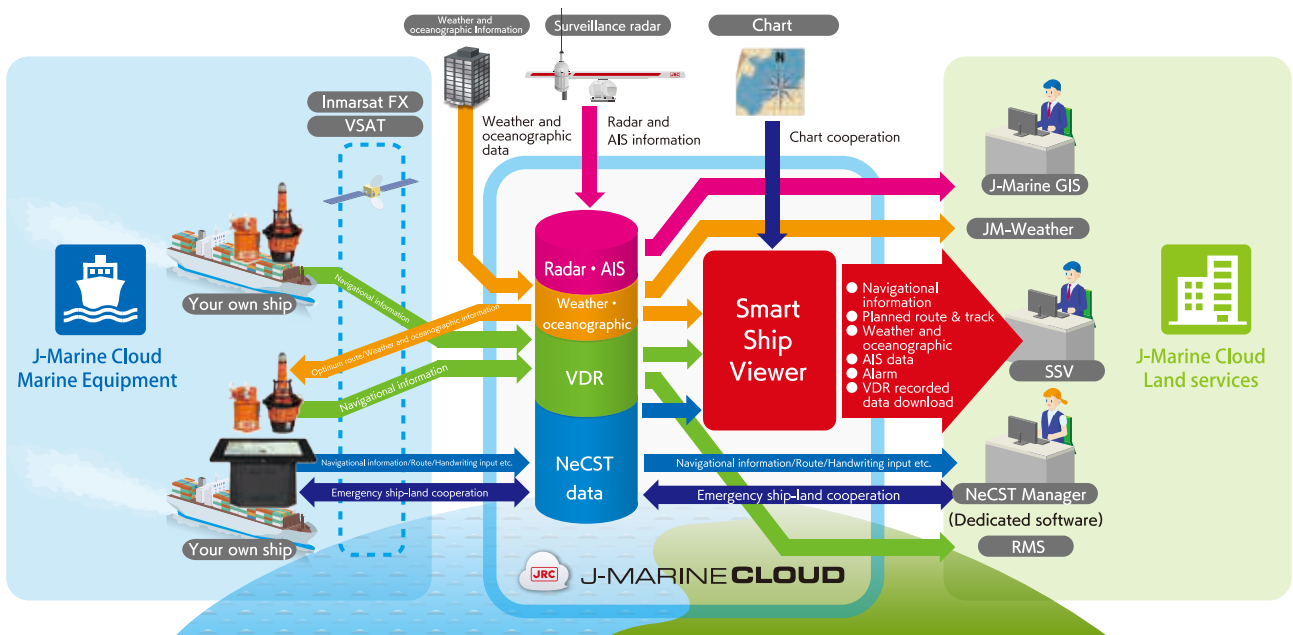

J-Marine NeCST



For more information,
Visit our website



The **JAN-470 series** is a navigation support equipment that manages and shares navigational information on a display including electronic charts. J-Marine NeCST includes a very useful input function that allows users' handwriting on electronic charts. It also integrates meteorological and hydrographical forecasts for preparation of optimal route plans. Moreover, electronic maps integration and linking with J-Marine Cloud will help users make more efficient and safer operations.



26-inch

46-inch

Information Service (J-Marine Cloud)

Smart Ship Viewer (SSV)

Smart Ship Viewer (SSV) supports economical, safe, and secure ship operation management, including the ship operation status of the vessel, through VDR data downloads and information sharing between vessels.

By installing JRC equipment on a ship having an always-on satellite communications device such as the Inmarsat FX, you can view the ship status whenever you want from a Web browser for enabling economical, safe, and secure ship operation management.

For more information,
Visit our website



Smart Ship Viewer [Fleet Viewer Display]

[Main Service]

- Ship Monitoring Service
- VDR Data Download Service
- Course Deviation Monitoring Feature
- Data Sharing Service
- Data Download Feature
- Distance and Other Measurement Features

- To use this feature, a Smart Ship Viewer subscription and a Smart Ship Viewer connection environment (Web browser) are required.
- A PC with an Internet connection is required on the shore side. A smartphone with a dedicated application installed is required to use SSV Mobile.
- The following are required on the vessel side: VDR/S-VDR, J-Marine NeCST, or J-Marine Box; and Inmarsat FX, VSAT, or other Internet-connected devices.

SSV Mobile

With **SSV Mobile**, you can view a list of the managed vessels on your smartphone screen. In addition to data such as the ship's name, the last time data was received, and latitude and longitude, SSV Mobile can also show whether an emergency has occurred and the status of the JRC navigation equipment installed on the ship.

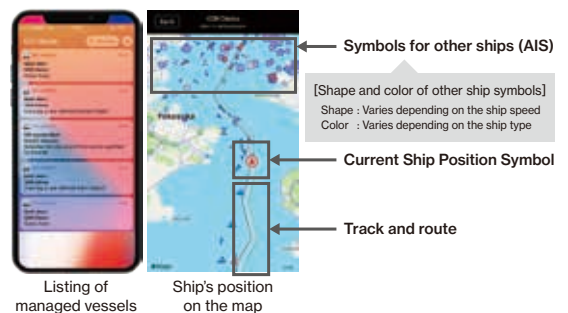

NeCST Manager

NeCST Manager enables real-time bidirectional information sharing between NeCST-equipped vessels and onshore. It enables smooth linkage between the vessel and shore through features such as an emergency ship-shore linkage function that enables real-time sharing of onboard status with the shore in the event of an emergency, and a ship operation management information display function that is linked with NeCST-equipped vessels and enables marine weather information to be superimposed onto the display of the managed vessel.

Each side updates the same file for real-time sharing of emergency situations



- To use NeCST Emergency, a Smart Ship Viewer subscription and an environment connected to Smart Ship Viewer are required.
- To use all the features of NeCST Emergency, the vessel must be equipped with NeCST Manager.



Remote Maintenance System (RMS)

Simplify Maintenance!

Remote Maintenance System (RMS) is a remote-diagnostic function of JRC's navigation and communication equipment by using JRC's VDR equipment as a remote server. Ship-to-land communication uses satellite circuits to realize highly secure communication regardless of location. JRC's navigation and communication equipment incorporates a remote maintenance function that includes a self-diagnostic function and can be easily introduced by adding wiring from each equipment to the VDR.

Remote Diagnosis

Diagnoses the operational status by connecting directly to the equipment from shore without needing any special actions by crewmembers.

Reduced Maintenance Costs

By monitoring and analyzing the operational state of the equipment, parts can be replaced at the right time. In this way, planned maintenance contributes to lower maintenance costs.

For more information, Visit our website



Satellite Connection

Connects to the vessel using a satellite link. Diagnostics can be performed in all oceans of the world except the polar regions.

Onboard Software Update Function

Software updates of onboard equipment can be performed even while the vessel is out at sea for enabling the equipment to be up to date at all times.

Use Existing Equipment

The system uses JRC's VDR equipment already installed on the ship. No additional options are required.

RMS Conceptual Diagram

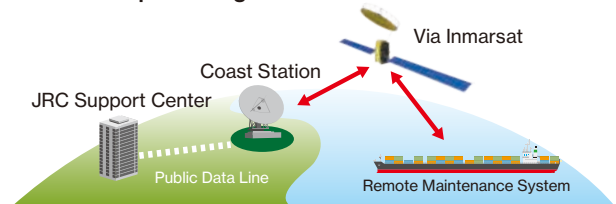

Life Cycle Management (LCM)

Life Cycle Management (LCM) is a service that contributes to lower Total Cost of Ownership (TCO) until your vessel is sold or scrapped. This service is not limited to maintenance of JRC radio and navigational equipment on board vessels, but also contributes to the efficiency of operations both on the ship and on shore through the use of our Remote Maintenance System (RMS)^{*1}, Information Service (J-Marine Cloud)^{*1}, and J-Marine NeCST^{*1}.

JRC's LCM proposal provides a menu of options for annual maintenance based on parts and consumables replacement information that incorporates the need for satisfying rules using JRC's own ship servicing record and equipment refurbishment information that takes into account the maintenance period.

Annual maintenance:

JRC Marinefonet provides a flat-fee annual maintenance service that includes the simultaneous replacement of parts and consumables that need to be replaced under the rules when conducting annual inspections, checks of the condition and for aging of equipment including its appearance, and implementation of measures as needed.

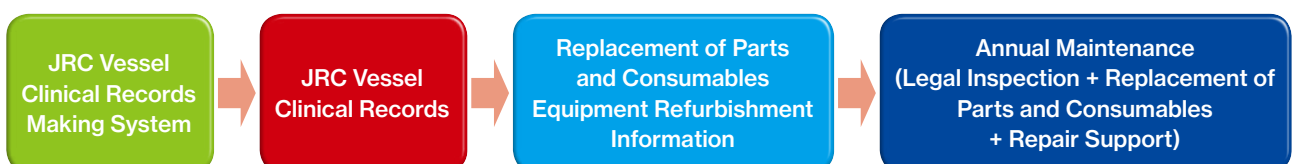

*1: These services have described separately.

JRC Global Service Network



JRC Global Service Network

Since our inception, JRC has been actively engaged in product sales as well as after-sales service in the field. Today, we offer 24-hour, 365-day-a-year service through a global network linking branch offices, sales offices, and more than 200 authorized distributors worldwide.



JRC one-call

Support Number

If you need our assistance, you can always call us at the same number: +81 50 3786 9201, no matter where you are, anytime, from anywhere in the world.



First Aid Kit (FAK)

Parts Deployment^{*1}

We conduct distributor training at each of our locations (Tokyo, Rotterdam, Singapore, Houston, Shanghai, and South Korea) and focus on training high-quality engineers to ensure that all customers are satisfied with our services. We also provide training programs for customers to explain equipment operation and more.

^{*1}: We store approximately 500 spare parts at one location (23 locations in addition to Tokyo).



Training

Training Program

We have parts available as First Aid Kits at our worldwide locations. Even if you are on a tight schedule, we will ship your parts order in the minimum amount of time.



Annual Maintenance

Perfect Service

We recommend our annual maintenance and service contracts, which are available for all locations and are tailored to the individual customer.

FAK Deployment Bases

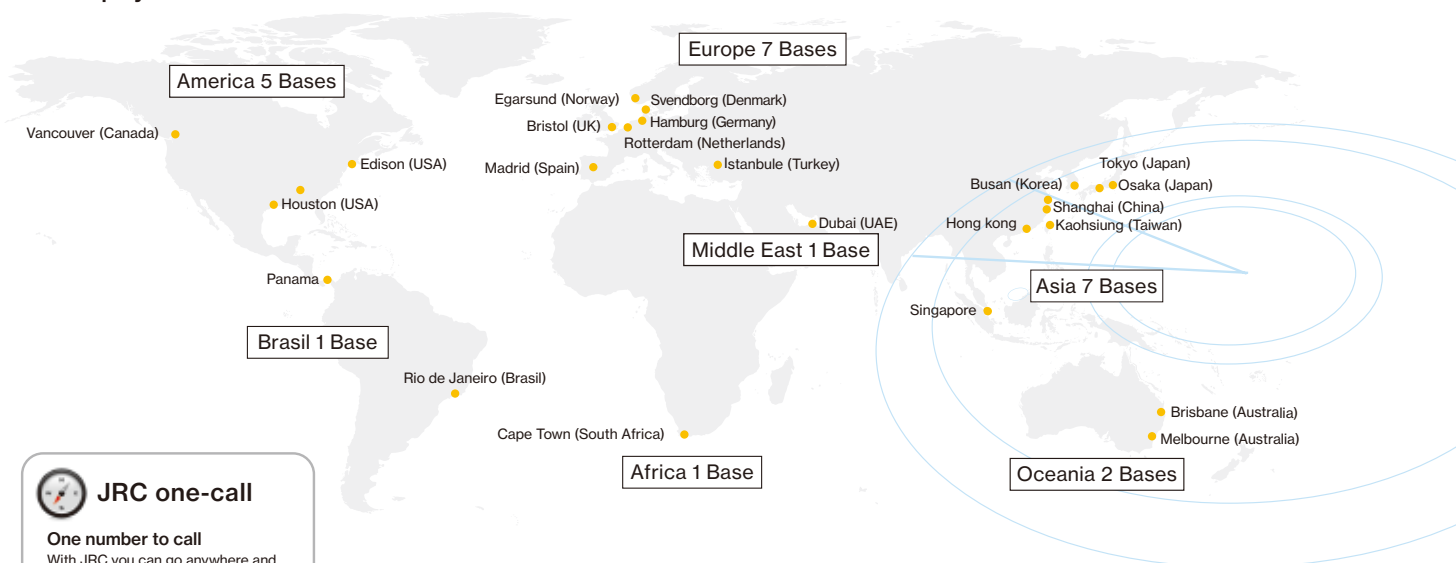

JRC one-call

One number to call
With JRC you can go anywhere and if you need our support, simply call us at +81 50 3786 9201, anytime.



• Specifications may be subject to change without notice.

For further information, contact:



Since 1915

Japan Radio Co., Ltd.

URL <https://www.jrc.co.jp/eng/>

Tatsumi Office: 7-32, Tatsumi 1-chome, Koto-ku, Tokyo
135-0053, Japan

Telephone: +81-3-5534-1207

Facsimile : +81-3-5534-1199

Overseas Branches : Athens, Manila

Liaison Offices : Taipei, Hanoi, New York

Overseas Subsidiaries : Busan, Shanghai, Singapore

Jakarta, Rotterdam, Egersund

Houston, Rio de Janeiro

36EM

ISO9001, ISO14001 Certified